

Cylindrical Proximity Sensor

E2EG

A New Series of Robust Proximity Switches Building on the Performance of the TLX-E Range

- CE marked.
- Stronger body, cord protector and metal connector for a more durable switch.
- Yellow LED conforming to IEC standards.
- Short body with longer thread and tightening flats.

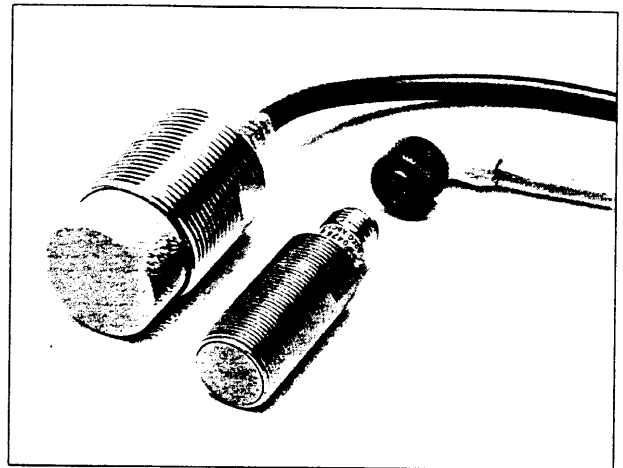

Ordering Information

E2EG

DC 3-wire/Pre-wired

Shield	Size	Sensing distance	Output configuration	Part number	
				NPN	PNP
Shielded	M8	1.5 mm	NO	E2EG-X1R5C1	E2EG-X1R5B1
	M12	2 mm	NO	E2EG-X2C1	E2EG-X2B1
	M18	5 mm	NO	E2EG-X5C1	E2EG-X5B1
	M30	10 mm	NO	E2EG-X10C1	E2EG-X10B1
Unshielded	M8	2 mm	NO	E2EG-X2MC1	E2EG-X2MB1
	M12	5 mm	NO	E2EG-X5MC1	E2EG-X5MB1
	M18	10 mm	NO	E2EG-X10MC1	E2EG-X10MB1
	M30	18 mm	NO	E2EG-X18MC1	E2EG-X18MB1

DC 3-wire/M12 Plug-in

Shield	Size	Sensing distance	Output configuration	Part number	
				NPN	PNP
Shielded	M8	1.5 mm	NO	E2EG-X1R5C1-M1	E2EG-X1R5B1-M1
	M12	2 mm	NO	E2EG-X2C1-M1	E2EG-X2B1-M1
	M18	5 mm	NO	E2EG-X5C1-M1	E2EG-X5B1-M1
	M30	10 mm	NO	E2EG-X10C1-M1	E2EG-X10B1-M1
Unshielded	M8	2 mm	NO	E2EG-X2MC1-M1	E2EG-X2MB1-M1
	M12	5 mm	NO	E2EG-X5MC1-M1	E2EG-X5MB1-M1
	M18	10 mm	NO	E2EG-X10MC1-M1	E2EG-X10MB1-M1
	M30	18 mm	NO	E2EG-X18MC1-M1	E2EG-X18MB1-M1

Note: Normally closed versions are available. Please contact Omron for availability.

■ TLX-E to E2EG Cross Referenes

DC 3 wire, 2m cable

Shield	Size	Existing	New
Shielded	M8	TL-X1R5B1-GE	E2EG-X1R5B1
		TL-X1R5C1-GE	E2EG-X1R5C1
	M12	TL-X2B1-GE	E2EG-X2B1
		TL-X2C1-GE	E2EG-X2C1
	M18	TL-X5B1-GE	E2EG-X5B1
		TL-X5C1-GE	E2EG-X5C1
M30	TL-X10B1-GE	E2EG-X10B1	
	TL-X10C1-GE	E2EG-X10C1	

Shield	Size	Existing	New
Unshielded	M8	TL-X2MB1-GE	E2EG-X2MB1
		TL-X2MC1-GE	E2EG-X2MC1
	M12	TL-X5MB1-GE	E2EG-X5MB1
		TL-X5MC1-GE	E2EG-X5MC1
	M18	TL-X10MB1-GE	E2EG-X10MB1
		TL-X10MC1-GE	E2EG-X10MC1
	M30	TL-X18MB1-GE	E2EG-X18MB1
		TL-X18MC1-GE	E2EG-X18MC1

DC 3 wire, M12 connector

Shield	Size	Existing	New
Shielded	M8	TL-X1R5B1-P1E	E2EG-X1R5B1-M1
		TL-X1R5C1-P1E	E2EG-X1R5C1-M1
	M12	TL-X2B1-P1E	E2EG-X2B1-M1
		TL-X2C1-P1E	E2EG-X2C1-M1
	M18	TL-X5B1-P1E	E2EG-X5B1-M1
		TL-X5C1-P1E	E2EG-X5C1-M1
M30	TL-X10B1-P1E	E2EG-X10B1-M1	
	TL-X10C1-P1E	E2EG-X10C1-M1	

Shield	Size	Existing	New
Unshielded	M8	TL-X2MB1-P1E	E2EG-X2MB1-M1
		TL-X2MC1-P1E	E2EG-X2MC1-M1
	M12	TL-X5MB1-P1E	E2EG-X5MB1-M1
		TL-X5MC1-P1E	E2EG-X5MC1-M1
	M18	TL-X10MB1-P1E	E2EG-X10MB1-M1
		TL-X10MC1-P1E	E2EG-X10MC1-M1
	M30	TL-X18MB1-P1E	E2EG-X18MB1-M1
		TL-X18MC1-P1E	E2EG-X18MC1-M1

■ Part Number Breakdown

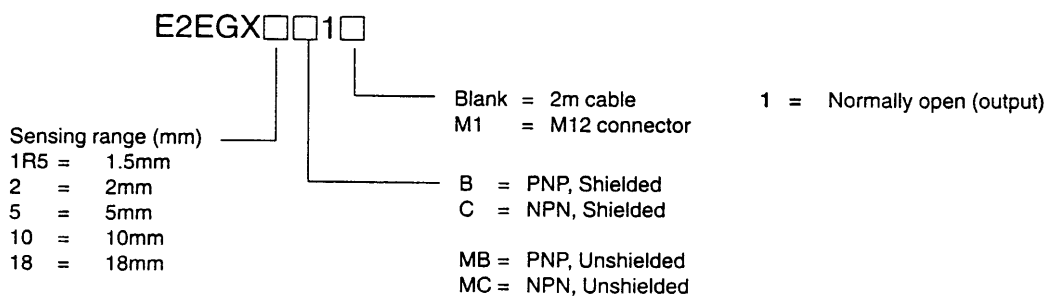

Accessories

■ Cables for E2EG****M1 Proximity Switches

M12 Single Keyway Female connectors, PVC cable, 4 wire

Description		Part Number
Angled 90°	2m	804 001 E03 M020
	5m	804 001 E03 M050
Straight	2m	804 000 E03 M020
	5m	804 000 E03 M050

Connector Type

Straight Female

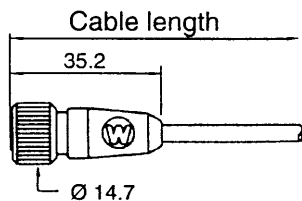

90° Female

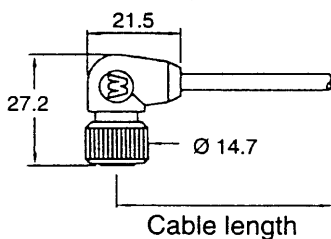

Wiring Information

4 wire

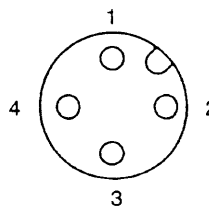

FEMALE

Pin No.	Wire
1	Brown
2	White
3	Blue
4	Black

■ Replacement table from Y92E**** to 804****

Description	3 wire current	4 wire 'Brad Harrison'
	Old Part Number	Replacement
Angled 90°	Y92E-P1D3V2	804 001 E03 M020
	Y92E-P1D3V5	804 001 E03 M050
Straight	Y92E-P1D3H2	804 000 E03 M020
	Y92E-P1D3H5	804 000 E03 M050

■ Mounting Brackets

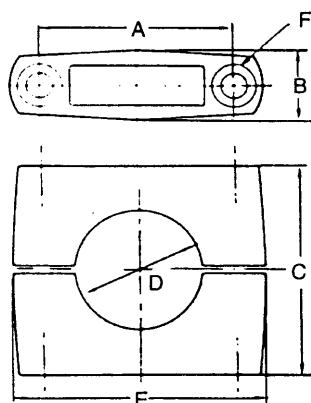

Proximity size	Type	Dimension A	Dimension B	Dimension C	Dimension D (dia.)	Dimension E	Dimension F (Hexagon bolt)
M8	Y92E-B8	18 ± 0.2	10 max.	18	8	28 max.	M4 x 20
M12	Y92E-B12	24 ± 0.2	12.5 max.	20	12	37 max.	M4 x 25
M18	Y92E-B18	32 ± 0.2	17 max.	30	18	47 max.	M5 x 32
M30	Y92E-B30	45 ± 0.2	17 max.	50	30	60 max.	M5 x 50

Specifications

■ Ratings/Characteristics

E2EG-X□C□/B□ DC 3-wire Models

Item	E2EG-X1R5 C1/B1	E2EG-X2M C1/B1	E2EG-X2 C1/B1	E2EG-X5M C1/B1	E2EG-X5 C1/B1	E2EG-X10M C1/B1	E2EG-X10 C1/B1	E2EG-X18M C1/B1	
Size	M8		M12		M18		M30		
Type	Shielded	Unshielded	Shielded	Unshielded	Shielded	Unshielded	Shielded	Unshielded	
Sensing distance	1.5 mm ±10%	2 mm ±10%	2 mm ±10%	5 mm ±10%	5 mm ±10%	10 mm ±10%	10 mm ±10%	18 mm ±10%	
Supply voltage (operating voltage range) (see note)	12 to 24 VDC, ripple (p-p): 10% max., (10 to 40 VDC)								
Current consumption	13 mA max.								
Sensing object	Magnetic metals (refer to "Engineering Data" for non-magnetic metals)								
Setting distance	0 to 1.2 mm	0 to 1.6 mm	0 to 1.6 mm	0 to 4.0 mm	0 to 4.0 mm	0 to 8.0 mm	0 to 8.0 mm	0 to 14.0 mm	
Standard object (mild steel)	8 x 8 x 1 mm	12 x 12 x 1 mm	12 x 12 x 1 mm	15 x 15 x 1 mm	18 x 18 x 1 mm	30 x 30 x 1 mm	30 x 30 x 1 mm	54 x 54 x 1 mm	
Differential travel	10% max. of sensing distance								
Response frequency	2.0 kHz	0.8 kHz	1.5 kHz	0.4 kHz	0.6 kHz	0.2 kHz	0.4 kHz	0.1 kHz	
Control output (switching capacity)	200 mA max.		200 mA max. (300 mA max. at 55°C or less) NPN or PNP open collector						
Circuit protection	Reverse connection protection, surge absorber, load short-circuit protection								
Indicator	Operation indicator (yellow LED)								
Ambient temperature	Operating: -40°C to 70°C (with no icing)								
Ambient humidity	Operating: 35% to 95%								
Temperature influence	±15% max. of sensing distance at 23°C in temperature range of -40°C to 70°C ±10% max. of sensing distance at 23°C in temperature range of -25°C to 70°C								
Voltage influence	±1% max. of sensing distance in rated voltage range ±15%								
Residual voltage	M8: 2.0 V max. (under load current of 200 mA with cable length of 2 m) M12 to M30: 2.0 V max. (under load current of 300 mA with cable length of 2 m)								
Insulation resistance	50 MΩ min. (at 500 VDC) between current carry parts and case								
Dielectric strength	1,000 VAC for 1 min between current carry parts and case								
Vibration resistance	Destruction: 10 to 55 Hz, 1.5-mm double amplitude for 2 hrs each in X, Y, and Z directions								
Shock resistance	500 m/s ² (approx. 50G) for 10 times each in X, Y, and Z directions			1,000 m/s ² (approx. 100G) for 10 times each in X, Y, and Z directions 500 m/s ² (approx. 50G) for E2E-X5M					
Enclosure rating	IEC IP67								
Weight	Pre-wired	Approx. 45 g		Approx. 120 g		Approx. 160 g		Approx. 270 g	
	Connector	---	Approx. 25 g			Approx. 45 g		Approx. 125 g	Approx. 124 g
Material	Case	Stainless steel		Nickel plated brass					
	Sensing surface	PBT							

E2EG-X10C□/B□

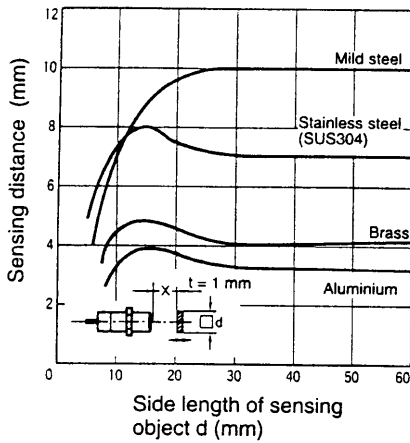

E2EG-X2MC□/B□

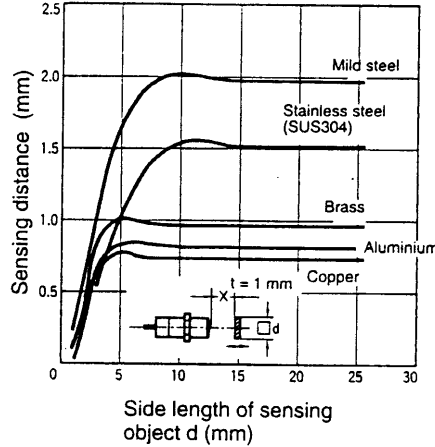

E2EG-X5MC□/B□

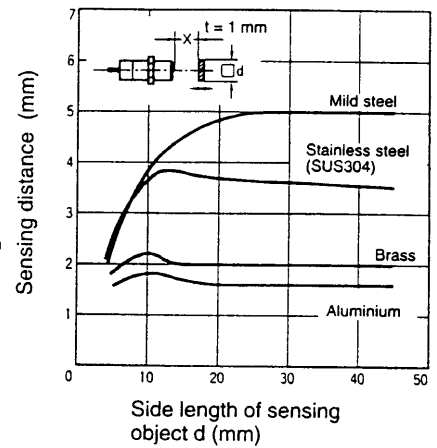

E2EG-X10MC□/B□

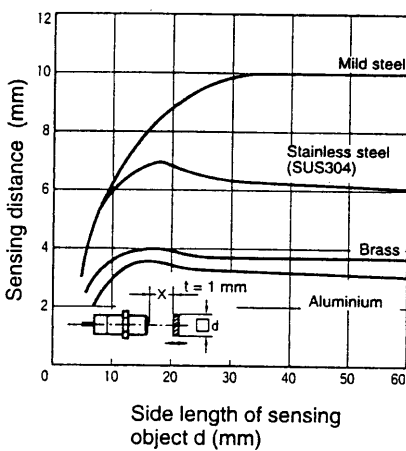

E2EG-X18MC□/B□

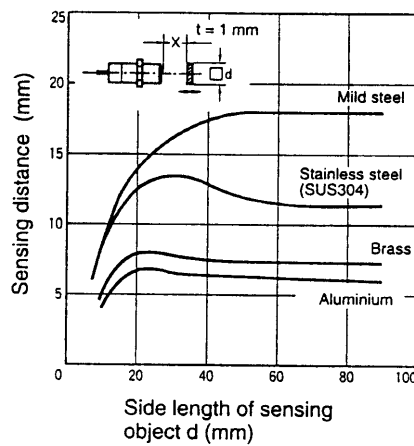

Operation

Output Circuits

E2EG

E2EG-X□C□

NPN Open Collector Output

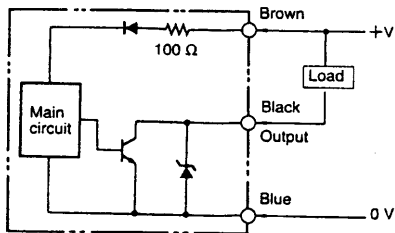

E2EG-X□B□

PNP Open Collector Output

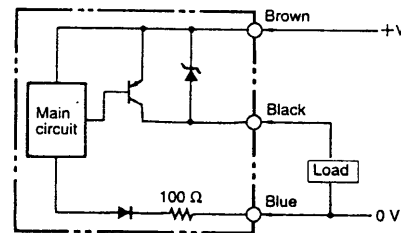

Operating Chart

E2EG

E2EG-X□C□/B□

NPN/PNP Open Collector Output

		N/O
Sensing object	Yes	
	No	
Red indicator	Lit	
	Not lit	
Control output	ON	
	OFF	

Engineering Data

E2EG

Operating Range (Typical)

Shielded Models

E2EG-X□C1/B1

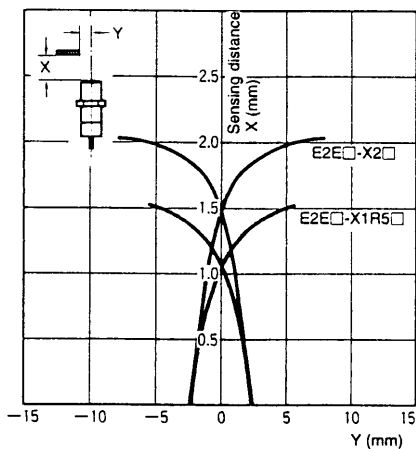

E2EG-X□C1/B1

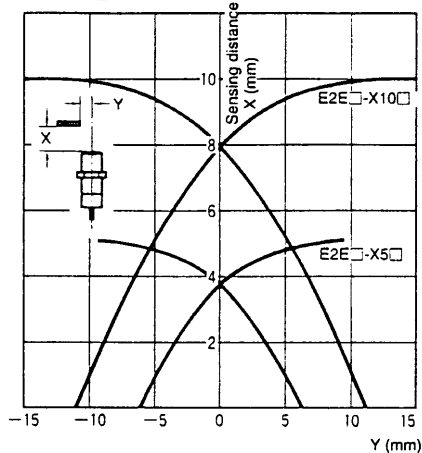

Unshielded Models

E2EG-X□MC1/B1

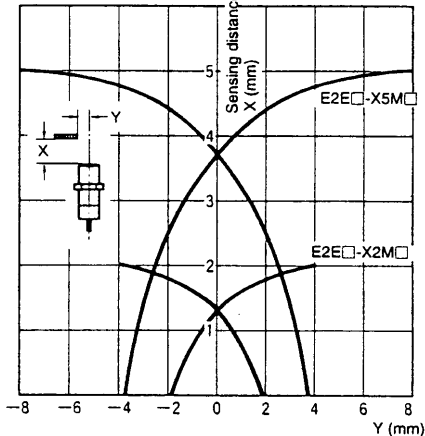

E2EG-X□MC1/B1

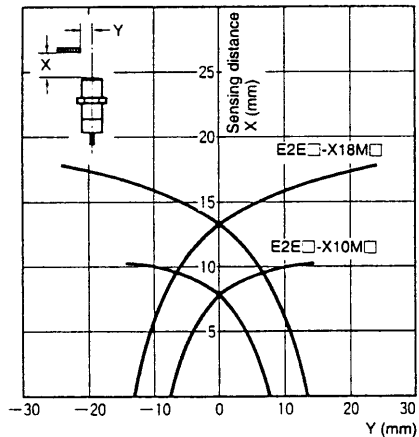

Sensing Distance vs. Sensing Object (Typical)

E2EG-X1R5C1/B1

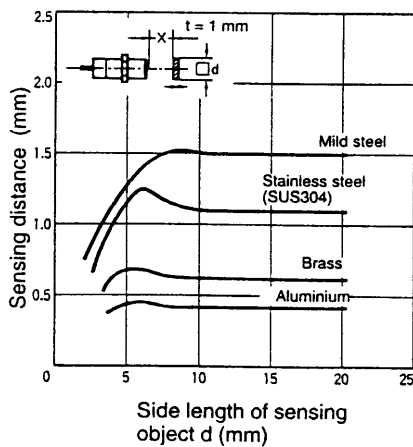

E2EG-X2C1/B1

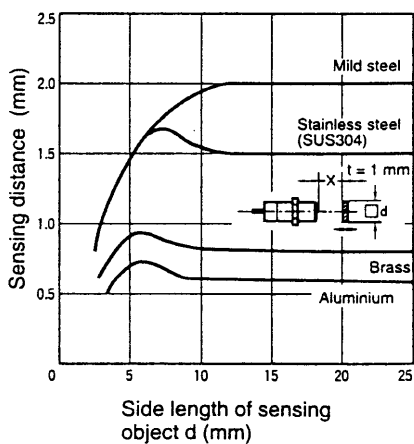

E2EG-X5C1/B1

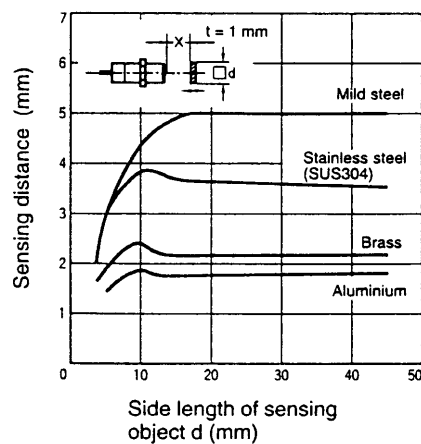

Dimensions

Pre-wired Models (Shielded)

Fig. 1 : E2EG-X1R5C1/B1

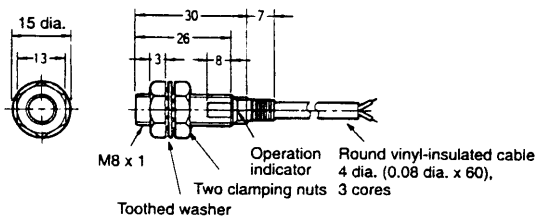

Pre-wired Models (Unshielded)

Fig. 2 : E2EG-X2MC1/B1

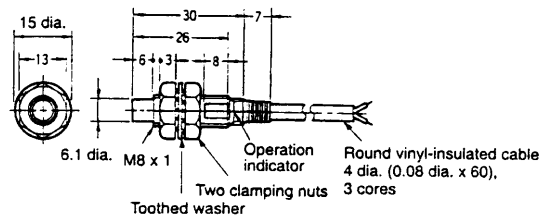

Fig. 3 : E2EG-X2C1/B1

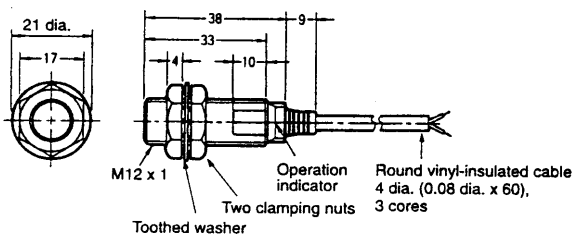

Fig. 4 : E2EG-X5MC1/B1

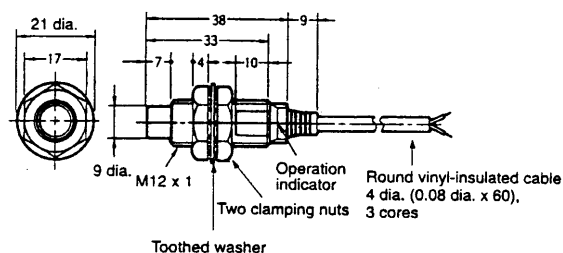

Fig. 5 : E2EG-X5C1/B1

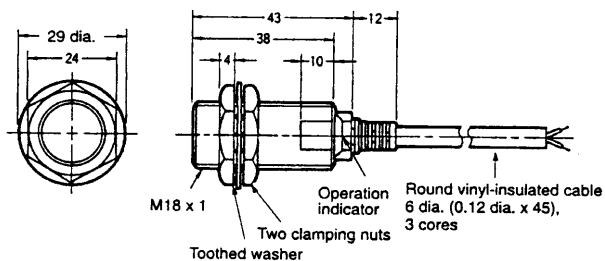

Fig. 6 : E2EG-X10MC1/B1

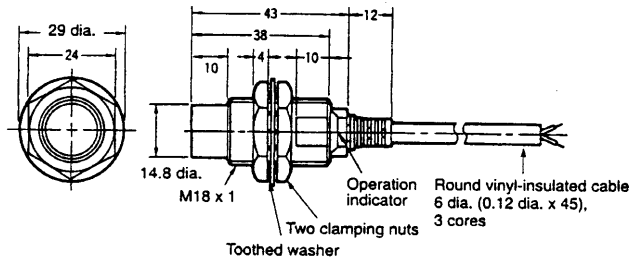

Fig. 7 : E2EG-X10C1/B1

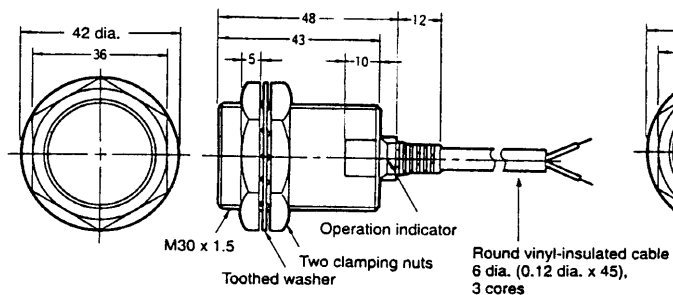
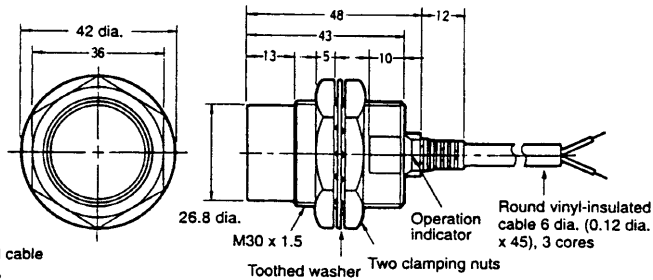

Fig. 8 : E2EG-X18MC1/B1



Connector Models
(Shielded)

Fig. 9 : E2EG-X1R5C1-M1/B1-M1

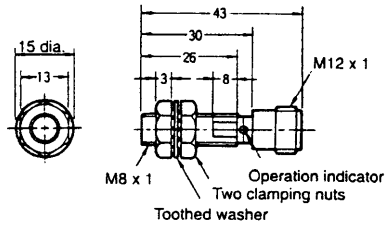

Fig. 11 : E2EG-X2C1-M1/B1-M1

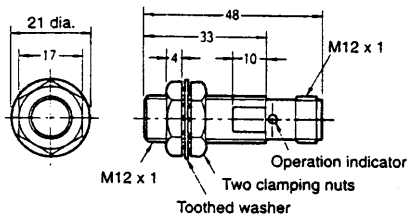

Fig. 13 : E2EG-X5C1-M1/B1-M1

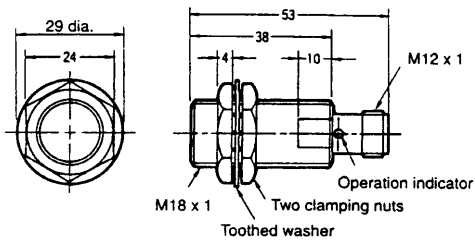
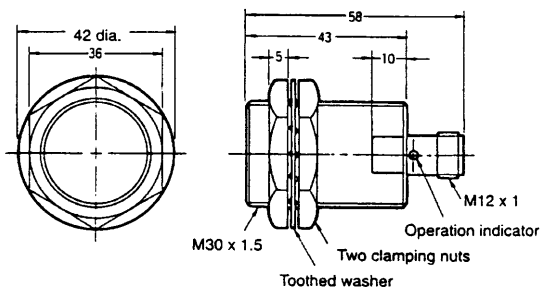

Fig. 15 : E2EG-X10C1-M1/B1-M1



Connector Models
(Unshielded)

Fig. 10 : E2EG-X2MC1-M1/B1-M1

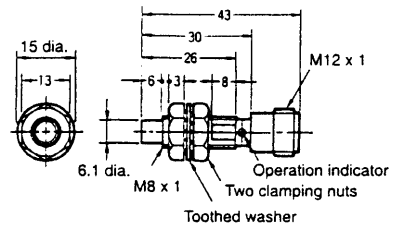

Fig. 12 : E2EG-X5MC1-M1/B1-M1

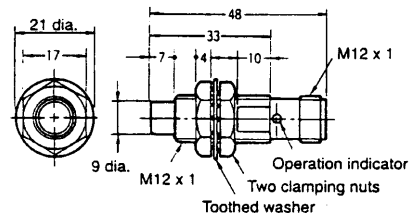

Fig. 14 : E2EG-X10MC1-M1/B1-M1

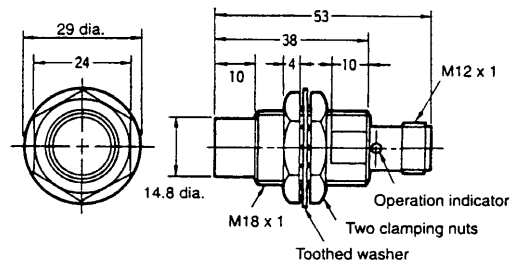
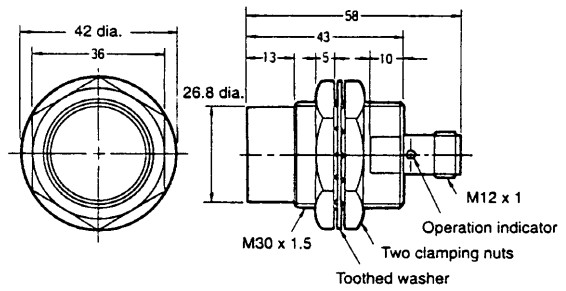

Fig. 16 : E2EG-X18MC1-M1/B1-M1



Installation

■ Connection

E2EG-X□C□
DC 3-wire Models

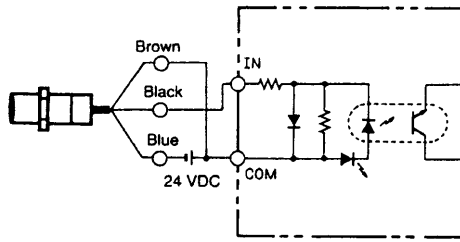

■ Pin Arrangement

E2EG-X□C□/B□-M1/M3

Connector	Output configuration	Applicable models	Pin arrangement
M12	NO	E2EG-X□C1-M1	<p>Note: Terminal 2 is not used.</p>
		E2EG-X□B1-M1	<p>Note: Terminal 2 is not used.</p>
	NC	E2EG-X□C2-M1	<p>Note: Terminal 4 is not used.</p>
		E2EG-X□B2-M1	<p>Note: Terminal 4 is not used.</p>

Precautions

Mounting

Do not tighten the nut with excessive force. A washer must be used with the nut.

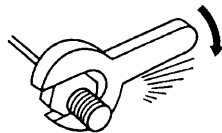

E2EG

Shielded Model

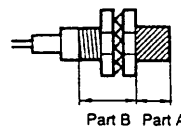

Unshielded Model

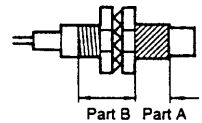

Note: The table below shows the tightening torques for part A and part B nuts. In the previous examples, the nut is on the sensor head side (part B) and hence the tightening torque for part B applies. If this nut is in part A, the tightening torque for part A applies instead.

Type		Part A		Part B
		Length	Torque	Torque
M8	Shielded	9 mm	9 N • m (91 kgf • cm)	12 N • m (120 kgf • cm)
	Unshielded	3 mm		
M12		30 N • m (310 kgf • cm)		
M18		70 N • m (710 kgf • cm)		
M30		180 N • m (1,800 kgf • cm)		

Effects of Surrounding Metal

When mounting the E2EG within a metal panel, ensure that the clearances given in the following table are maintained. Failure to maintain these distances may cause deterioration in the performance of the sensor.

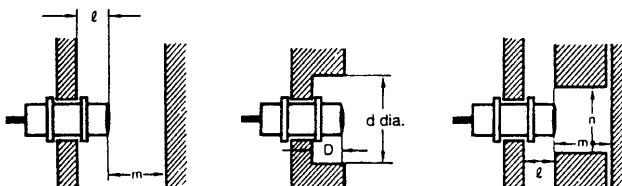

E2EG

Type	Item	M8	M12	M18	M30	
E2EG-X□C□ E2EG-X□B□ DC 3-wire	Shielded	ℓ	0 mm	0 mm	0 mm	0 mm
		d	8 mm	12 mm	18 mm	30 mm
		D	0 mm	0 mm	0 mm	0 mm
		m	4.5 mm	8 mm	20 mm	40 mm
		n	12 mm	18 mm	27 mm	45 mm
	Unshielded	ℓ	6 mm	15 mm	22 mm	30 mm
		d	24 mm	40 mm	55 mm	90 mm
		D	6 mm	15 mm	22 mm	30 mm
		m	8 mm	20 mm	40 mm	70 mm
		n	24 mm	36 mm	54 mm	90 mm

Mutual Interference

When installing two or more Sensors face to face or side by side, ensure that the minimum distances given in the following table are maintained.

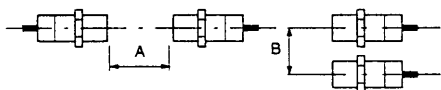

E2EG

Type	Item	M8	M12	M18	M30	
E2EG-X□C□ E2EG-X□B□ DC 3-wire	Shielded	A	20 mm	30 mm	50 mm	100 mm
		B	15 mm	20 mm	35 mm	70 mm
	Unshielded	A	80 mm	120 mm	200 mm	300 mm
		B	60 mm	100 mm	110 mm	200 mm

⚠ Caution

Item	Examples
Power supply Do not impose an excessive voltage on the E2EG, otherwise it may explode or burn. Do not impose 100 VAC on any E2EG DC model, otherwise it may explode or burn.	
Load short-circuit Do not short-circuit the load, or the E2EG may explode or burn. The E2EG's short-circuit protection function is valid if the polarity of the supply voltage imposed is correct and within the rated voltage range.	
Wiring Be sure to wire the E2EG and load correctly, otherwise it may explode or burn.	

■ Correct Use

Installation

Power Reset Time

The Proximity Sensor is ready to operate within 100 ms after power is supplied. If power supplies are connected to the Proximity Sensor and load respectively, be sure to supply power to the Proximity Sensor before supplying power to the load.

Power OFF

The Proximity Sensor may output a pulse signal when it is turned off. Therefore, it is recommended to turn off the load before turning off the Proximity Sensor.

Power Supply Transformer

When using a DC power supply, make sure that the DC power supply has an insulated transformer. Do not use a DC power supply with an auto-transformer.

Wiring

High-tension Lines

Wiring through Metal Conduit

If there is a power or high-tension line near the cord of the Proximity Sensor, wire the cord through an independent metal conduit to prevent against Proximity Sensor damage or malfunctioning.

Cord Tractive Force

Do not pull cords with the tractive forces exceeding the following:

Diameter	Tractive force
4 dia. max.	30 N max.
4 dia. min.	50 N max.

Mounting

The Proximity Sensor must not be subjected to excessive shock with a hammer when it is installed, otherwise the Proximity Sensor may be damaged or lose its water-resistivity.

Environment

Water Resistivity

Do not use the Proximity Sensor underwater, outdoors, or in the rain.

Operating Environment

Be sure to use the Proximity Sensor within its operating ambient temperature range and do not use the Proximity Sensor outdoors so that its reliability and life expectancy can be maintained. Although the Proximity Sensor is water resistive, a cover to protect the Proximity Sensor from water or water soluble machining oil is recommended so that its reliability and life expectancy can be maintained. Do not use the Proximity Sensor in an environment with corrosive gas (e.g., strong alkaline or acid gases including nitric, chromic, and concentrated sulphuric acid gases).

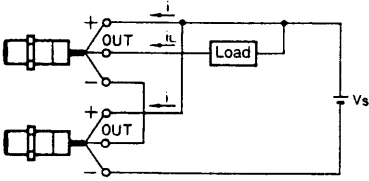
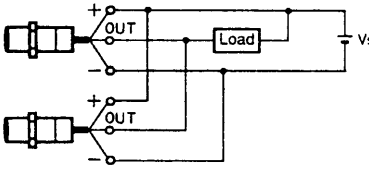
Connection type	Method	Description
AND (serial connection)	<p style="text-align: center;">Correct</p> 	<p>The sensors connected together must satisfy the following conditions.</p> <p>$i_L + (N - 1) \times i \leq$ Upper-limit of control output of each Sensor</p> <p>$V_S - N \times V_R \geq$ Load operating voltage</p> <p>N: No. of sensors V_R: Residual voltage of each sensor V_S: Supply voltage <i>i</i>: Current consumption of the sensor i_L: Load current</p> <p>If the MY Relay, which operates at 24 VDC, is used as a load for example, a maximum of two Proximity Sensors can be connected to the load.</p>
OR (parallel connection)	<p style="text-align: center;">Correct</p> 	<p>A minimum of three sensors with current outputs can be connected in parallel. The number of Sensors connected in parallel varies with the Proximity Sensor model.</p>

ALL DIMENSIONS SHOWN ARE IN MILLIMETRES.

To convert millimetres into inches, multiply by 0.03937. To convert grams into ounces, multiply by 0.03527.

Cat. No. I-E2EG-001 In the interest of product improvement, specifications are subject to change without notice.

OMRON

LEADERS IN ADVANCED TECHNOLOGIES

OMRON Electronics Ltd.

1, Apsley Way,
Staples Corner,
London NW2 7HF
Phone: (0181) 450 4646 Fax: (0181) 450 8087